



Avaya 3735 DECT Handset Quick Reference Guide

Release 4.6
July 2017
© 2017, Avaya Inc.
All Rights Reserved.

3735 DECT handset overview

The Avaya 3735 DECT handset is a robust DECT handset designed for medium to high demand environments such as hospitals, elderly care, retail and enterprise. Its advanced messaging features make it ideal for applications where two-way messaging or interaction with automated equipment is required.

The Avaya 3735 DECT handset streamlines maintenance or administration and can easily be adapted to fit the changing needs of large and diversified organizations.

3735 handset physical layout

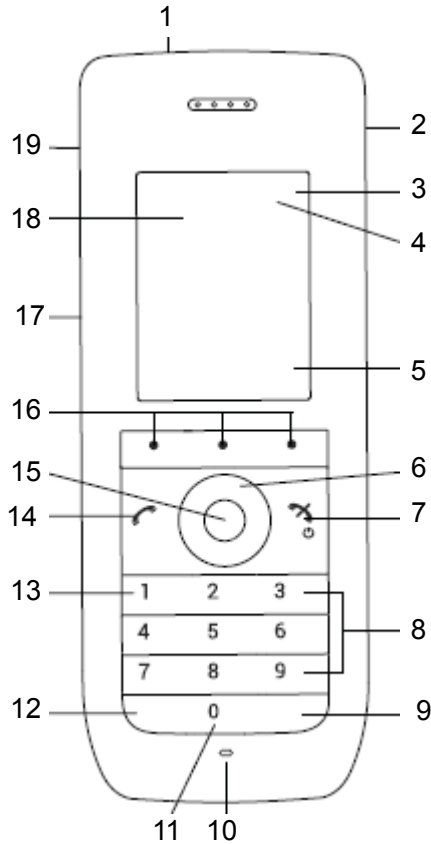

Callout number #	Name
1	Multifunction/Alarm button
2	Headset connector
3	Shows time and icons
4	Shows date and icons
5	Shows the soft key function
6	Five way navigation key.
7	On hook and On/Off key
8	Alphanumeric keys
9	Sound off key
10	Microphone
11	Space

Table continues...

Callout number #	Name
12	Key lock, and Upper and Lower case
13	Voicemail access
14	Off hook key
15	Confirmation key
16	Soft keys
17	Mute button
18	Color display
19	Volume buttons

Functions

* Note:

Some functions are license/system dependent or require settings in handset via WinPDM/Device Manager.

Table 1: Functions of 3735 DECT handset

Functions	3735	3735 Alarm
General		
Easy registration	✓	✓
Enhanced DECT Security	✓	✓
Vibrator	✓	✓
Headset connector	✓	✓
Loudspeaking function	✓	✓
3 Programmable Soft keys	✓	✓
9 Programmable Hot keys	✓	✓
Profiles	✓	✓
System profiles	✓	✓

Table continues...

Functions	3735	3735 Alarm
Shared phone	✓	✓
Contacts (250 contacts)	✓	✓
Central phonebook	✓	✓
Company phonebook (1000 contacts)	✓	✓
Downloadable languages	✓	✓
Multifunction button	✓	—
Programmable Navigation key	✓	✓
Upgradable to Messenger	—	—
Upgradable to Protector	✓	—
Centralized management	✓	✓
Personalized menus	✓	✓
Easy replaceable battery	✓	✓
Easy replacement of handset	✓	✓
Handset restrictions	✓	✓
Bluetooth	✓	✓
Telephony		
Push to Talk (PTT)	✓	✓
Procedure call	✓	✓

Table continues...

Functions	3735	3735 Alarm
Voicemail access	✓	✓
Microphone on/off during call	✓	✓
Five predefined emergency numbers	✓	✓
Messaging		
Mini messaging (12 characters)	—	—
Data Send	✓	✓
Colored messaging	✓	✓
Interactive messaging	✓	✓
Data with prefix	✓	✓
Alarm		
Push button alarm	—	✓
Acoustic Location Signal (ALS)	—	✓
Alarm with data	—	✓
Location		
Location, base stations	✓	✓

Icons



















Icon	Name
	Signal strength
	Full battery
	Voicemail message
	Microphone off

Table continues...

Icon	Name
	Loudspeaking
	Loudspeaking off
	Sound off
	Headset
	Bluetooth headset
	Bluetooth
	New message
	Read message
	Missed call
	Incoming call
	Outgoing call
	System connection
	Key lock
	Phone lock

Handset menu and keys

Menu icons

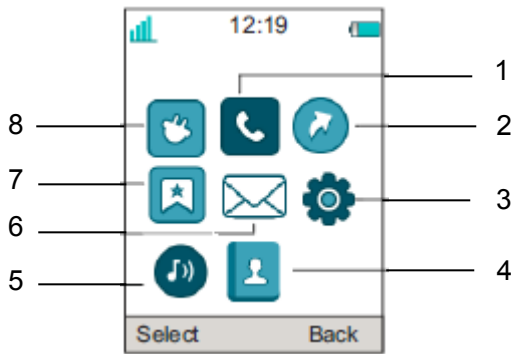

Callout number #	Name
1	Calls
2	Shortcuts
3	Settings
4	Contacts
5	Profiles
6	Messaging
7	My favorites
8	Connections

Navigating the menu

1. To move around in the menu structure, use the **Navigation** key.
2. To select an option, press the corresponding soft key located below the display.

Soft keys, Hot keys, and Multifunction button

The three soft keys below the display can be defined for specific functions such as dialling a specific number.

A long press on a **Hot** key can have the same function as a **Soft** key and any key between **2 - 9** can be programmed as a **Hot** key.

The **Multifunction** button can also be programmed for different functions with the use of long press and double press.

Activating automatic key lock

1. Press **Menu**.

2. Select **Settings**.
3. Select **Locks > Automatic key lock**.
4. Select one of the following:
 - **On**
 - **On except calls**

The system displays the current key lock setting under **Automatic key lock**.

5. Press **Back** to redisplay the **Locks** menu.
6. Select **Auto lock time**, and then press **Select**.
7. Select the required lock time, and then press **Select**.
The user can configure a locked keypad to unlock automatically when a call or message is received. After the user has serviced the call or message, the keypad is locked again after the specified **Auto lock time** expires.

Deactivating automatic key lock

1. Press **Menu**.
2. Select **Settings**.
3. Select **Locks > Automatic key lock**.
4. Select **Off** to deactivate automatic key lock.

Basic functions

Switching the handset on

1. Press and hold the **On-hook and On/Off** () key.
The handset vibrates when it is on and the display lights up followed by a confirmation message.
2. Press **Yes**.

Switching the handset off

The handset must be in an idle mode.

1. Press and hold the **On-hook and On/Off** () key.
The system displays the Switch off? window.
2. To confirm, press **Yes**.
If a handset is shared and one of the users logs off the shared handset, the lock that prevents the handset from unauthorized use is deactivated.

Charging the battery

To charge the battery, place the handset in any of the following:

- Desktop charger: In a desktop charger the handset is fully operational. The handset does not vibrate in charger.
- Charging rack

You can also charge the handset in a separate battery pack charger.

Charging below 5°C will harm the battery and shorten the lifetime.

Replacing the battery

If the standby time for the handset becomes too low, replace the battery by a new battery.

Contact the system administrator or handset supplier for information about new batteries.

Making a call

To dial the number and make a call, do any of the following:

- In standby mode, dial the number and press the **Off-hook** key, or the soft key **Call**.
- Press the **Off-hook** key and select number from the **Call list**.
- Press a pre-programmed **Hot** key or **Soft** key.
- Press a soft key.
- To dial a number from the local phone book, enter **Contacts > Call contact**. Select the name from the list and press **Call** or the **Off-hook** key.
- To dial a number from the Central phone book, enter **Contacts > Central phonebook**. Search by **Name** or **Number** or **Last result**, and press **Search**. Press **Off-hook** key, or the soft key **Call**.

The alpha-numeric keys can be programmed with a handset number.

Answering a call

When the ring signal sounds, press the **Off-hook** key.

Ending a call

Some systems or PBXs require that the handset sends a DTMF in order to end a call.

To end a call, press the **On-hook and On/Off** () key.

Declining a call

Your handset must ring.

Press the **On-hook and On/Off** () key or the **Decline** soft key.

Turning the loudspeaking function on or off

During a call, press the left soft key to turn the loud speaking function on or off.

Turning audio signals on or off

Do the following:

- In stand-by mode a long press on the **Sound off** key, or a long press on the **Mute** button changes between audio signals on or off.

The **Sound off** icon indicates a silenced handset.

- A short press on the **Sound off** key or a press on the **Mute** button before answering a call, silences the ring signal.

Setting the vibrator alert

1. Press **Menu**.
2. Select **Settings**.
3. Select **Sound & Alerts > Vibrator alert**.
4. Select one of the following:
 - **On**
 - **On if silent**: The vibrator is on when the handset is muted.
 - **Off**
5. Select vibrating alert.
6. Press **Back** to save the settings.

* Note:

If the vibrator is activated, it vibrates for incoming calls and messages. The vibrator can also be activated when receiving a message during a call.

Changing the volume during a call

Do any of the following:

- Press the **Volume** button upwards to increase the volume and downwards to decrease the volume.
- Use the **Navigation** key to adjust the volume.

Locking or unlocking the keypad manually

Press the * key to lock or unlock and then press the soft key **Lock** or **Yes**.

The **Locked keypad** icon indicates a locked keypad.

Text messages on 3735 DECT handset

When a text message is received, a message tone sounds. The message is displayed immediately and the **New message** icon is shown in the display.

If the message is received during a call, the user is notified by a beep and the message is displayed. The message is stored in the message list.

Messaging availability is dependent on handset variant.

Reading a stored message

1. Press **Menu**.
2. Select **Messaging**.
3. Select **Inbox** to view the message list.
4. Select a message, and then press **View**.

You can scroll the message list with the up and down arrows on the navigation key.

Writing a new message

1. Press **Menu**.
2. Select **Messaging**.
3. Select **Write new message**.
4. Write the message from scratch or select a message template by pressing the **More** soft key and, if required, edit the message.

* Note:

The **More** key is not displayed if no message templates have been defined.

5. When the message is complete, press **Send**.
6. Enter the call number.
7. Press **Send** to send the message.

Deleting a message

1. Press **Menu**.
2. Select **Messaging**.
3. Select **Inbox** to view the message list.
4. Select a message that you want to delete, and then press **More**.

You can scroll the message list with the up and down arrows on the navigation key.
5. Select **Delete**, and then press **Yes**.

The system deletes the message.
6. **(Optional)** To delete all messages in the list, select **Delete all** and press **Yes**.

Checking the voicemail

Do any of the following:

- When you receive a new voicemail, it is indicated by the **New voice mail** icon, and an automatically displayed voice mail notification, then press **Call** to call your voice mail and listen to the message.
- In standby mode, call your voicemail by long pressing on the digit key **1**.
- Select **Messaging > Inbox**. Select the voicemail message, press **View**, and then press **Call**.

If the extension number is not available, the system displays the Voice mail number not defined dialogue window.

All voice mail are indicated with one icon only, in the message list.

Using the local phone book

Use the phone book to:

- Find and call a name.
- Add a contact.
- Edit a contact.
- Delete a contact.

1. To find and call a name, do the following:
 - a. Select **Contacts > Call contact**.
 - b. Do one of the following:
 - Enter the first few letters in the name or the whole name. While entering the text, suggestions that match the entry are displayed in the **Search** field.
 - Go to the contact list.
 - c. Select the name, and press **Call**.
2. To add a new contact, do the following:
 - a. Select **Contacts > Add contact**.
 - b. Select **New** or **From call list**.
 - c. Press **Add**.
 - d. Enter the name, and press **OK**.
 - e. Select **Number**, enter the number, and press **OK**.
 - f. Press **Save**.
3. To edit a contact, do the following:
 - a. Select **Contacts > Edit contact**.
 - b. Select the name, and press **Edit** twice.
 - c. Make the required changes, press **OK**, and then press **Save**.

A contact from the company phone book is marked with the , which means that it is not editable.
4. To delete a contact, do the following:
 - a. Select **Contacts > Delete contact**.
 - b. Select the name, press **Delete**, and then press **Yes**.

Using the central phone book

The central phone book looks for contacts in central company phone book database.

1. Select **Contacts > Central phonebook**.

2. Select any of the following:
 - **Search by name**
 - **Search by number**
 - **Last result**
3. Enter the first letter(s) in the first name, and/or the first letter(s) in the family name.
4. Press **Search**.

The system searches the central phone book and displays a list of matching names.
5. **(Optional)** You can step to the next entry in alphabetic order by pressing the **Navigation** key.
6. Press **More** to add contact, or press **Call** or the **Off-hook** key to make the call.

Alarm functions

Activating an alarm

You can always trigger the alarm when you are speaking, editing your settings, or while the handset is locked.

To activate the alarm, press the alarm button twice within two seconds.

The system displays an information text `Personal alarm`.

The alarm is sent to the alarm central that distributes it further. After that the handset returns to stand-by mode.

Acoustic location signal

An alarm can be followed by an Acoustic Location Signal (ALS). The ALS is a signal from the handset that sounds for a predefined period of time. The signal is silenced by pressing the Mute button on the handset.

Testing the alarm

Press and hold the alarm button until the system displays the information text `Test Alarm`.

Alarm with data

The data must manually be defined and stored by the user. To use the function, one Soft or Hot key or Navigation key in the handset must be defined as a shortcut to the menu **Edit alarm data**. The stored data is added to all types of alarm at transmission.

Automatic call after alarm

A handset can be configured to call a predefined number after an alarm has been sent. If configured, it is also possible to call the predefined number without sending an alarm by pressing the push-button. Depending on the

settings, the call can be established in the following modes:

- Loudspeaking mode
- Normal mode
- Monitor mode

Chemical resistance

The alpha and numeric characters printed on the exterior of the handset have been tested and found resistant to chipping, fading, or wearing off when the handset is treated with common cleaners and disinfectants or perspiration. Do not immerse the handset in any solutions; use a damp rag for cleaning application. The following chemicals have shown no harmful effect:

- Ethanol 85%
- Aseptix, H2O2
- Sodium hypochlorite 5%
- Chlorhexidin 60% 0,5 mg/ml
- Actichlor plus, 1000 ppm chlorine
- Virkon S 1%

*** Note:**

Acetone can be damaging to the plastic casing of the handset and should not be used.

Support

Go to the Avaya Support website at <http://support.avaya.com> for the most up-to-date documentation, product notices, and knowledge articles. You can also search for release notes, downloads, and resolutions to issues. Use the online service request system to create a service request. Chat with live agents to get answers to questions, or request an agent to connect you to a support team if an issue requires additional expertise.